

8684B
SIGNAL GENERATOR
5.4—12.5 GHz
(Including Option 003)

SERIAL NUMBERS

This manual applies directly to instruments with serial numbers prefixed 2138A.

For additional important information about serial numbers, see INSTRUMENTS COVERED BY THIS MANUAL in Section I.



**HEWLETT
PACKARD**

© Copyright HEWLETT-PACKARD COMPANY 1981
1501 PAGE MILL ROAD, PALO ALTO, CALIFORNIA, U.S.A.



MODEL 8684B

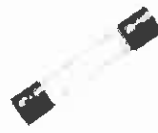

FUSE

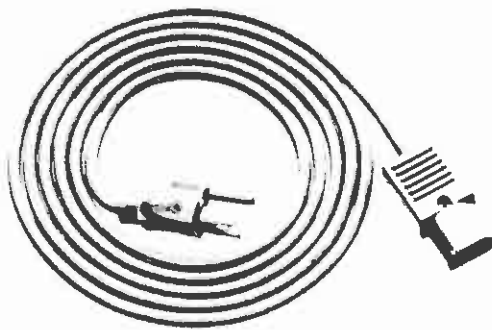

LINE POWER CABLE

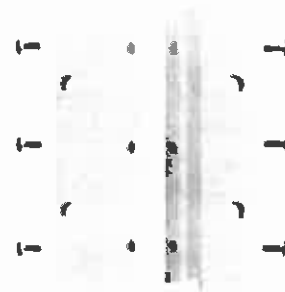

OPTION 913
RACK FLANGE KIT

Figure 1-1. HP Model 8684B Signal Generator with Accessories Supplied and Option Available

SECTION I GENERAL INFORMATION

1-1. INTRODUCTION

This manual contains information required to install, operate, test, and service the Hewlett-Packard Model 8684B Signal Generator. The Signal Generator is shown in Figure 1-1 with all of its externally supplied accessories and the available rack mounting option. This manual also documents Option 003 which adds the capability of operating from 48 to 440 Hz power sources.

This section of the manual covers the instrument description, options, accessories, specifications, and other basic information. The remaining sections cover the following information.

- Section II Installation
- Section III Operation
- Section IV Performance Tests
- Section V Adjustments
- Section VI Replaceable Parts
- Section VII Manual Changes
- Section VIII Service

Two copies of the operating information are supplied with the Signal Generator. One copy is in the form of an Operating Manual and simply is a copy of the first three sections of the Operating and Service Manual. It should remain with the instrument for use by the operator. The other copy provided is the Operating and Service Manual which should be retained by the technicians responsible for the periodic servicing of the instrument. Additional copies of either manual may be ordered through your nearest Hewlett-Packard sales office. The part numbers are listed on the title page of this manual.

The Operating and Service Manual is also available in microfiche form, and the microfiche part number is also listed on the title page. This number may be used to order the 100 x 150 mm (4 by 6 inch) microfilm transparencies. Each transparency contains up to 98 photo-duplicates of the manual pages and the package includes the latest manual change supplements.

1-2. SPECIFICATIONS

Instrument specifications are listed in Table 1-1. These specifications are the performance stan-

dards or limits against which the instrument may be tested. Supplemental characteristics are listed in Table 1-2. Supplemental characteristics are not warranted specifications, but are typical characteristics included as additional information for the user.

1-3. SAFETY CONSIDERATIONS

This product is a Safety Class I instrument (i.e., provided with a protective earth terminal). The Signal Generator and all related documentation must be reviewed for familiarization with safety markings and instructions before operation. Refer to the Safety Considerations page found at the beginning of this manual for a summary of the safety information. Safety information pertinent to the task at hand (installation, performance testing, adjustment, or service) will be found throughout the manual.

1-4. INSTRUMENTS COVERED BY THIS MANUAL

This instrument has a two-part serial number in the form of 0000A00000. The number is stamped on the serial number plate attached to the rear panel of the instrument. The first four digits and the letter constitute the serial number prefix, and the last five digits form the suffix. The prefix is the same for all identical instruments, and it changes only when a change is made to the instrument. The suffix, however, is assigned sequentially and is different for each instrument. The contents of this manual apply directly to instruments having the same serial number prefix(es) as listed under Serial Numbers on the title page.

An instrument manufactured after the printing of this manual may have a serial number prefix that is not listed on the title page. This unlisted serial number prefix indicates that the instrument is different from those documented in the manual. The manual for a newer instrument is accompanied by a yellow Manual Changes supplement which contains the change information that explains how to adapt the manual to the newer instrument.

In addition to change information, the supplement may contain information for correcting

INSTRUMENTS COVERED BY THIS MANUAL (cont'd)

errors in the manual. In order to keep your manual as current and accurate as possible, it is recommended that you periodically request the latest Manual Changes supplement. The supplements are identified with the manual print date and part number, both of which appear on the manual title page. Complimentary copies of the supplements are available from Hewlett-Packard.

For information concerning a serial number prefix that is not listed on the title page or in the Manual Changes supplement, contact your nearest Hewlett-Packard office.

1-5. DESCRIPTION

The Hewlett-Packard Model 8684B is a cavity tuned, microprocessor enhanced, solid-state signal generator with a microwave output frequency range of 5.4 to 12.5 GHz. Its output is leveled and calibrated over the range of +10 dBm to -120 dBm, and power is available down to approximately -130 dBm. Internal amplitude modulation in the form of a 1 kHz square wave or FM in the form of a 1 kHz sawtooth may be individually selected, and the maximum frequency deviation of the FM may be adjusted from the front panel. An internal pulse generator may also be used to pulse modulate the microwave output. It includes both step and vernier controls for the pulse rate, pulse delay (referenced to a front-panel SYNC OUT signal), and pulse width. The internal pulse generator can be triggered by an external source that determines the pulse rate while the front-panel DELAY and WIDTH controls determine those characteristics. An external pulse generator may also be used to establish the pulse modulation characteristics. Whether derived from external or internal sources, AM, FM, and pulse modulation may be applied individually or in various combinations. However, interlocks provided by the microprocessor controlled system prevent the selection of two sources for the same type of modulation. For example, external AM and internal FM can be selected at the same time; external FM and internal FM cannot be selected at the same time. One other prohibited combination is the selection of the INT 1 kHz square wave along with the selection of internal or external pulse modulation. When a conflict occurs, the Signal Generator automatically turns off the previously selected mode and turns on the most recently selected mode.

The Signal Generator uses seven-segment digital LED displays to show the output frequency, modu-

lation level, and output level. Smaller LED indicators in each pushbutton key provide an immediate indication of whether or not that particular function is active. Other LED indicators provide warnings when the output is not properly leveled, when overmodulation is occurring, and when an improper combination of pulse parameters is selected.

The cable offset feature provides a front-panel key for turning the offset on and off, and a rear-panel control for entering cable length (up to 4.5 metres of RG-214 cable). Using the cable length data and the frequency of the Signal Generator output, the microprocessor computes the cable loss and then, operating through the automatic level control system, increases the output power level to compensate for the calculated losses. When the cable offset is turned on, the power level displayed by the Signal Generator is the computed power level at the end of the selected cable length. When the cable offset is turned off, the power level displayed by the Signal Generator is the level at the OUTPUT connector of the Signal Generator.

The setting of the rear-panel CABLE OFFSET control appears in the LEVEL display when the CABLE OFFSET key is held down. This makes it easy to verify the setting of the control or to adjust it to a new setting. The display resolution is one-tenth of a metre.

The Signal Generator has an extensive set of built-in diagnostic procedures that will rapidly identify most of the troubles that are likely to occur, and many of the procedures are automatically executed when the instrument is turned on. If a malfunction is detected, an error code number or other special display indicates the assembly at fault. The power-up error codes are described in Section III, Operation, and are also included inside the instrument on the top cover.

A second and more extensive set of diagnostic routines can be accessed by removing the top cover and switching the instrument to the diagnostic mode. This mode allows a technician (using the front-panel switches and indicators) to select individual diagnostic routines that will check power supplies, modulator voltages, detector outputs, flip-flop operation, and many other analog and digital functions. No external test equipment is required for the power-up diagnostics or for most of the testing in the diagnostic mode. The diagnostic routines are fully described in Section VIII, Service, and a summary is included inside the instrument on the top cover.

DESCRIPTION (cont'd)

Since a fault in the microprocessor might prevent either of the first two diagnostic modes from operating, a third level of diagnostic procedures is required. This level is provided by the signature analysis mode. It requires the use of external test equipment, and it provides an efficient method of troubleshooting digital circuitry. The signature analysis procedures are described in Section VIII, Service.

1-6. OPTIONS**1-7. Electrical 400 Hz Line Frequency Operation (Option 003)**

Option 003 provides the additional capability of operating from 400 Hz power sources. Option 003 instruments can operate from line frequencies of 48 to 440 Hz, but operation at line frequencies greater than 66 Hz is limited to 100 or 120 Vac.

1-8. Mechanical Rack Flange Kit (Option 913)

This kit contains all necessary hardware and installation instructions for mounting the Signal Generator in a rack with standard 19-inch EIA (482.5 millimetres) spacing. The Signal Generator cabinet is 5-1/4 inches (133.4 mm) high. Order HP part number 5061-2071.

1-9. ACCESSORIES SUPPLIED

The accessories supplied with the Signal Generator are shown in Figure 1-1. The handles shown in the

illustration are standard. The line power cable will be supplied in one of several configurations, depending upon the country of destination for the original shipment from the factory. Refer to Power Cables in Section II of this manual.

1-10. ACCESSORIES AVAILABLE**1-11. Chassis Slide Mount Kit**

This kit is very useful when the Signal Generator is to be rack mounted. It permits access to internal circuits and components, and access to the rear panel is possible without removing the instrument from the rack. Order HP part number 1494-0018 for the slide mount kit, and part number 1494-0023 for the adapters to be used with non-HP rack enclosures.

1-12. Chassis Tilt Slide Mount Kit

This kit is similar to the Chassis Slide Mount Kit but it also allows the instrument to be tilted up or down 90°. Order HP part number 1494-0025 for tilting slides, and part number 1494-0023 for the adapters to be used with non-HP rack enclosures.

1-13. RECOMMENDED TEST EQUIPMENT

Table 1-3 lists the test equipment recommended for use in testing, adjusting, and servicing the Signal Generator. If any of the recommended equipment is not available, instruments with equivalent critical specifications may be substituted. Table 1-4 provides a list of recommended service accessories.

Table 1-1. Specifications (1 of 5)

Electrical Characteristics	Performance Limits	Conditions
FREQUENCY Range Display Resolution Calibration Accuracy	5.4 GHz to 12.5 GHz ≤ 10 MHz ≤ 9 GHz $\pm 1.25\%$ > 9 GHz $\pm 0.75\%$	See Table 1-2, Supplemental Characteristics Using $3\frac{1}{2}$ -digit 7-segment display
SPECTRAL PURITY Harmonics Spurious Output Residual FM	< -25 dBc < -80 dBc < 5 kHz peak	Up to 18 GHz at maximum specified power 50 Hz to 15 kHz post-detection bandwidth
RF OUTPUT Level Range Level Accuracy ¹ Display Resolution Level Flatness	+10 dBm to -130 dBm ± 2.5 dB ± 3.5 dB 0.1 dB ± 1.0 dB	Leveled into 50 ohms From maximum output to -110 dBm From < -110 dBm to -120 dBm Using a $3\frac{1}{2}$ -digit 7-segment display With indicated power level > -10 dBm
GENERAL MODULATION SPECIFICATIONS Types Internal AM Internal FM Internal Pulse External AM External FM External Pulse Simultaneous AM/FM, AM/Pulse, FM/Pulse, or AM/FM/Pulse Metering	1 kHz (nominal) square wave 1 kHz (nominal) sawtooth 3-digit LED display	
¹ Accuracy error includes allowances for metering accuracy, detector linearity, temperature, flatness, harmonics, attenuator accuracy, and measurement error. Accuracy specifications apply only to the top 15 dB of the LEVEL vernier range.		

Table 1-1. Specifications (2 of 5)

Electrical Characteristics	Performance Limits	Conditions
<p>AMPLITUDE MODULATION²</p> <p>AM Depth</p> <p>AM Distortion (Total Harmonic Distortion)</p> <p>AM Rates³</p> <p>Incidental FM</p> <p>Internal AM</p>	<p>0 to 70%</p> <p><10% at 40% depth and 1 kHz rate.</p> <p>dc to 10 kHz</p> <p>50 Hz to 10 kHz</p> <p><15 kHz peak-to-peak</p> <p>Fixed 1 kHz (nominal) square wave with a duty cycle of 50 ±5%.</p> <p>On-Off ratio >80 dB at maximum power.</p>	<p>At 1 kHz rate</p> <p>dc coupled 40% AM depth (3 dB bw)</p> <p>ac coupled 40% AM depth (3 dB bw)</p> <p>30% AM depth</p>
<p>FREQUENCY MODULATION</p> <p>Peak Deviation</p> <p>FM Rates</p> <p>Incidental AM</p> <p>Internal FM</p> <p>Distortion</p>	<p>5 MHz</p> <p>dc to 10 MHz</p> <p>100 Hz to 10 MHz</p> <p><6%</p> <p>Fixed 1 kHz (nominal) sawtooth with variable deviation up to the maximum specified deviation.</p> <p>A 1 kHz sawtooth signal with a nominal amplitude of 1V peak is available at the FM INPUT/OUTPUT connector.</p> <p><5%</p>	<p>dc coupled (3 dB bw)</p> <p>ac coupled (3 dB bw)</p> <p>With <100 kHz rate and <1 MHz peak deviation</p> <p>With 100 kHz rate and <1 MHz peak deviation.</p>
<p>EXTERNAL PULSE INPUT REQUIREMENTS</p> <p>Rate</p>	<p>0 to 1 MHz</p>	<p>See Table 1-2, Supplemental Characteristics</p>

² Amplitude modulation specifications are valid for the LEVEL vernier range of 5 to 15 dB below the maximum vernier setting with output levels at least 5 dB below the specified maximum output power.

³ AM rate is limited to a maximum of 500 Hz when AM is combined with pulse modulation.

Table 1-1. Specifications (3 of 5)

Electrical Characteristics	Performance Limits	Conditions
EXTERNAL PULSE INPUT REQUIREMENTS (cont'd)		
Width	>100 ns	
On Level	>1.0V	dc coupled
Off Level	<0.4V	dc coupled
RF PULSE OUTPUT		
Rise and Fall Time	<10 ns	
Minimum Pulse Width	<100 ns	
Video Feedthrough	25 mV peak	At maximum specified power
Maximum Pulse Rate	1 MHz	
Maximum Delay Time (Time between VIDEO OUT and RF OUTPUT pulses)	<100 ns	
Pulse Width Compression	<50 ns	
Minimum Duty Cycle	0.01%	Output may be unlevelled below 0.01%
Peak Pulse Power	Within ± 0.5 dB of level set in CW mode	For top 10 dB of LEVEL vernier range
On-Off Ratio	>80 dB	At maximum leveled power
INTERNAL PULSE GENERATOR		
Pulse Rate	10 Hz to 1 MHz in five ranges with continuous adjustment within ranges.	
Pulse Delay (Time between SYNC OUT and VIDEO OUT pulses)	<50 ns to 100 ms in seven ranges with continuous adjust- ment within ranges.	The range below 100 ns is not calibrated. The pulse delay must be $\leq 90\%$ of pulse period.
Pulse Width	<100 ns to 100 ms in seven ranges with continuous adjust- ment within ranges.	
Calibration Accuracy (Pulse Rate, Pulse Delay, and Pulse Width)	20% of full scale	

Table 1-1. Specifications (4 of 5)

Electrical Characteristics	Performance Limits	Conditions
GENERAL		
Operating Temperature Range	0°C to 55°C	
Power Requirements Line Voltage	100, 120, 220 or 240 Vac, +5%, -10%	
Line Frequency	48 to 66 Hz	All specified line voltages may be used
	Option 003 adds 48 to 440 Hz operation	Limited to line voltages of 100 or 120 Vac when line frequency is >66 Hz
Power Dissipation	<200 VA	
Conducted and Radiated Interference	MIL-STD-461A	Conducted and radiated interference is within the requirements of CE03, CS01, CS02, CS06, RE02, RS01, and RS03 of MIL- STD-461A. Also within the requirements of VDE 0871 and CISPR Publication 11.
Operating and Non-operating Environment	Temperature, humidity, shock, and vibration Type Tested to MIL-T-28800B Class IV Requirements.	
Safety	Meets requirements of IEC 348	
Net Weight	16.0 kg (35 lb)	

Table 1-1. Specifications (5 of 5)

Electrical Characteristics	Performance Limits	Conditions
<p>GENERAL (cont'd) Dimensions: Full envelope Height x Width x Depth</p>	<p>145 H x 457 W x 495.5 mmD (5.75 H x 18 W x 19.5 inches D)</p>  <p>Note: dimensions in millimetres and (inches)</p>	<p>Note: For ordering cabinet accessories, the module sizes are 5 1/4 H, 1 MW, and 17 D.</p>

Table 1-2. Supplemental Characteristics (1 of 2)

Supplemental characteristics are intended to provide information useful in applying the instrument by giving typical, but non-warranted performance parameters.

FREQUENCY

Frequency Stability: As a function of time, frequency stability is <30 kHz/minute 20 minutes after turn-on and <100 kHz/hour 60 minutes after turn-on (at a constant ambient temperature). Typically, frequency drift with respect to any passive load change is <10 kHz. The drift with respect to changes of 10 dB on the LEVEL vernier is <20 kHz, and the drift with respect to mode changes (CW to FM or FM to CW) is <25 kHz. Stability as a function of temperature is <30 MHz change over the range of 0°C to 55°C, and stability as a function of line voltage is <20 ppm for transient line changes from +5% to -10%.

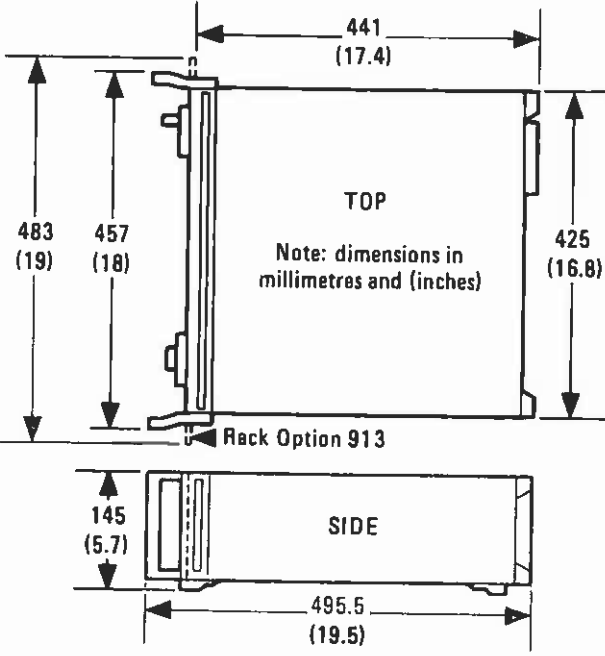
Tuning is accomplished via a rotary tuning control requiring approximately 20 turns to cover the full band in the normal tuning mode and approximately 200 turns to cover the full band in the fine-tuning mode. The tuning range extends approximately 200 MHz above and 50 MHz below the specified frequency range.

SPECTRAL PURITY

SSB Broadband Noise Floor: At maximum specified output level, the noise floor is <-145 dBc.

Residual AM (averaged rms): <0.1% in a 300 Hz to 15 kHz post-detection bandwidth.

SSB Phase Noise (averaged rms): <-65 dBc in a 1 Hz bandwidth offset 10 kHz from the carrier.



RF OUTPUT

Reverse power must not exceed 1 watt average nor 100 watts peak. Pulse energy (pulse power x pulse width) must not exceed 1 mW-s.

Typically, the output impedance is 50 ohms and the SWR is <2.5 for levels >-10 dBm, otherwise the SWR is <2.0.

Auxiliary Output: The signal at the rear-panel Type-N connector is typically >-15 dBm into 50 ohms; it is derived from the oscillator output before reaching the amplitude modulation or pulse modulation circuits. Therefore, the auxiliary output signal may be a CW signal or may include frequency modulation, but it cannot be amplitude modulated

or pulse modulated. The source impedance is approximately 50 ohms.

RF Power Level Display: The output level may be displayed in dBm or dB REL (relative to a user selected reference level). A CABLE OFFSET feature permits automatic correction of the power level so that the indicated level represents the level at the end of a known length of RG-214 cable.

AMPLITUDE MODULATION

External AM Sensitivity: Variable, and nominally is 100% AM per volt peak into 600 ohms with AM vernier at full cw position.

AM Display Accuracy: ±5% of full scale for depths up to 50% at a 1 kHz rate. The OVERMOD indicator may turn on in the top 5 dB of the specified LEVEL vernier range.

Maximum Allowable Input Level: ±5V peak.

FREQUENCY MODULATION

External FM Sensitivity: On both the 1 MHz/V and 10 MHz/V ranges, peak deviation (with FM vernier fully cw) is approximately 100% of selected range per volt peak. Nominal input impedance is 50Ω. FM sensitivity is lower at the low end of the frequency range; in the 1 MHz/V range, it typically is about 600 kHz/V.

Phase Lock Input: Rear-panel BNC connector with a typical sensitivity of -5 MHz/V. The input impedance is nominally 1 kΩ. The phase lock input sensitivity is lower at the low end of the frequency range.

FM Display Accuracy (10 MHz/V range): ±10% of full scale for deviations up to 5 MHz at a 100 kHz rate.

Maximum Allowable Input Level: 5V peak.

PULSE MODULATION

The SYNC OUT signal provides a >1V peak positive pulse into 50Ω. The nominal width is 20 ns.

The VIDEO OUT signal provides a >3V peak positive replica of the selected RF pulse.

Table 1-2. Supplemental Characteristics (2 of 2)

PULSE MODULATION (cont'd)

The EXT TRIG mode permits the pulse rate to be determined by an external source, while pulse delay and pulse width are determined by the Signal Generator DELAY and WIDTH controls. The external signal must be a positive-going signal of >1.0V, and it must have a width of >20 ns. Nominal input impedance is 50 Ω .

A pulse UNCAL annunciator warns the operator if an improper combination of RATE, DELAY, and/or WIDTH control settings has been selected. When the pulse delay is between 90% and 100% of the pulse period, the UNCAL annunciator may not indicate an uncalibrated condition. A capacitive load (long cable length without a proper termination) on the SYNC OUT or VIDEO OUT connectors may cause an erroneous UNCAL indication. To prevent this condition, be sure the cable is terminated with a 50 Ω load.

Ringings and overshoot are <10% after a 10 ns rise time.

The maximum allowable input level is $\pm 5V$ peak.

OVERMODULATION INDICATOR

The OVERMOD indicator lights and the MODULATION display shows 99.9 when external AM inputs cause more than 99.8% AM, when FM causes more than approximately 6 MHz deviation, or when any dc superimposed on the external FM signal results in positive or negative peak input amplitudes in excess of 1.2V. The AM and FM vernier controls may be pulled out to provide ac coupling and remove unwanted dc offsets from the INPUT signal.

RECORDER OUTPUTS

Two rear-panel BNC connectors provide analog output voltages suitable for driving X-Y recorders or strip chart recorders. One output provides a 0 to 10V FREQUENCY signal representing the specified tuning range, and the other output provides a RELATIVE VERNIER LEVEL signal representing the 0 to 25 dB range of the LEVEL vernier.

SERVICE MODES

An internally selected diagnostic service mode provides a series of microprocessor controlled test routines that will rapidly measure and display power supply voltages and various analog voltages. These routines will also verify normal operation of most of the digital circuitry involved. Many of these same tests are automatically performed when power is applied to the instrument, and diagnostic codes are displayed to indicate the nature of any malfunction detected.

A second service mode permits the use of a signature analyzer when troubleshooting the microprocessor and its associated circuitry.

An edge connector providing RS-232 type signals is available for connecting the microprocessor to an HP 2600 series terminal. With this arrangement, a single diagnostic routine simultaneously displays the voltages measured at 28 different points in the instrument. Any voltage that is out of tolerance is identified by underlining or by reverse video on the terminal display. Another routine displays the actual voltage transitions measured at the outputs of 32 flip-flops so an inoperative flip-flop can easily be identified.

Table 1-3. Recommended Test Equipment (1 of 2)

Instrument	Critical Specification	Recommended Model	Use ¹
50 MHz Reference Attenuator	Attenuation: 30 dB Accuracy: 30 dB \pm 0.05 dB at 50 MHz	11708A (Supplied with HP 8484A Power Sensor)	P, A, T
50 Ohm Feed-Thru Termination	Accuracy: \pm 1%	HP 10100C	P, T
70 MHz Modulator/ Demodulator	Distortion: <1% Must be capable of demodulating 10 MHz FM rates at 50 MHz deviation on a 70 MHz carrier.	HP 3717A	P
Amplifier	Gain: 20 dB at 20 kHz	HP 465A	P
Audio Analyzer	Internal Distortion: <1% at 10 kHz Provides 100 kHz source and 100 kHz distortion measurement. Must be capable of measuring 11 mV rms.	HP 8903A	P, A, T
Digital Voltmeter	Range: 0 to 30 Vdc Resolution: 0.01 Volt	HP 3455A	P, A, T
Diode Detector	Video Bandwidth: >5 MHz Frequency Range: 5.4 to 12.5 GHz	HP 8470B Opt. 012	P, A, T
Frequency Counter	Range: 5.4 GHz to 12.5 GHz	HP 5342A	P, A, T
Frequency Counter	Dual Channel, Differential Measurements	HP 5345A	P
Gain-Phase Meter	Frequency Range: 1 Hz to 13 MHz	HP 3575A Opt. 001	A
Logic Probe	Suitable for TTL and CMOS testing	HP 545A	T
Mixer ²	Frequency Range: 5.4 GHz to 12.5 GHz	RHG DM1-18	P, A, T
Modulation Analyzer	Frequency: 12.5 MHz Filters: 300 Hz high-pass and 15 kHz low-pass Residual AM <0.1%. Must be capable of FM measurement in presence of AM, must be capable of average and peak responding modulation measurements, and must provide demodulated AM and FM outputs.	HP 8901A	P, A, T
Oscilloscope	>200 MHz bandwidth	HP 1725A	P, A, T
Power Meter	Range: +10 dBm to -60 dBm Resolution: 0.1 dB Must be compatible with HP 8481A and HP 8484A Power Sensors.	HP 436A	P, T

¹ P = Performance Tests; A = Adjustments; T = Troubleshooting² RHG Electronics Laboratory, Inc., 161 East Industry Court, Deer Park, N.Y. 11729, Tel. (516) 242-1100, TWX 510-227-6083.

Table 1-3. Recommended Test Equipment (2 of 2)

Instrument	Critical Specification	Recommended Model	Use ¹
Power Sensor	Range: +10 dBm to -30 dBm Frequency: 5.4 GHz to 12.5 GHz Must be compatible with HP 436A Power Meter.	HP 8481A	P, T
Power Sensor	Range: -30 dBm to -60 dBm Frequency: 5.4 GHz to 12.5 GHz Must be compatible with HP 436A Power Meter.	HP 8484A	P, T
Pulse Generator	Rise and Fall Time: < 10 ns Pulse Width: ≤100 ns PRF: 0 to 1 MHz Pulse Amplitude: 3V to 5V peak	HP 8013B	P, A, T
Signal Generator	Frequency Range: 5.4 GHz to 12.5 GHz Output Power: +10 dBm	HP 8684B	P
Signature Analyzer	Minimum Pulse Width of 10 ns Data Probe Input Impedance: 50 kΩ Start, Stop, and Clock Input Impedance: 50Ω	HP 5004A	T
Spectrum Analyzer (Low Frequency)	20 kHz to 100 kHz measurement of -110 dBm signals.	HP 3580A	P, A, T
Spectrum Analyzer	Frequency Range: 5.4 GHz to 18.0 GHz Sensitivity: +10 dBm to -86 dBm Resolution: 100 kHz Zero scan capability at 0.2 ms/division Log and linear vertical scaling Video and free-run triggering	HP 8565A	P
Test Oscillator	Frequency Range: 50 Hz to 10 MHz Output: 1 volt into 50 ohms 1 volt into 600 ohms	HP 651B	P, A, T
¹ P = Performance Tests; A = Adjustments; T = Troubleshooting			

Table 1-4. Service Accessories

Accessory*	Specification	Suggested Model
Torque Wrench (SMA Connectors)	13±0.3 inch-pounds	Utica Tool Co.** "A" Series Preset Wrench, Model #CHA-5, 13±0.3 inch-pounds (requires 5/16-inch open-end wrench)
Open-End Wrench (SMA Connectors)	5/16-inch	Utica Tool Co. Open End Standard, Model #OP102, 5/16-inch
Torque Wrench (SMC Connectors)	4±0.3 inch-pounds	Utica Tool Co.** "A" Series Preset Wrench, Model #CHA-5, 4±0.3 inch-pounds (requires 1/4-inch open-end wrench)
Open-End Wrench (SMC Connectors)	1/4-inch	Utica Tool Co. Open End Standard, Model #OP82, 1/4-inch
Pliers (External Retaining Rings)		Model #P-102X90 Industrial Retaining Ring Co., 57 Cordier Street, Irvington, N.J. 07111
Extender Boards (Two Required)	36 contacts (2 x 18)	HP 08684-60018
Foam Pad	Conductive polyurethane foam, 12 x 12 x 0.25 inches	HP 4204-0094
<p>* Refer to Section VIII, Service, for applications. **Utica Tool Company, Inc., Orangeburg, SC 29115 or the nearest Utica Tool Company distributor.</p>		

SECTION II INSTALLATION

2-1. INTRODUCTION

This section provides the information needed to install the Signal Generator. Included is information pertinent to the initial inspection, power requirements, line voltage and fuse selection, operating environment, instrument mounting, storage, and shipment.

2-2. INITIAL INSPECTION

WARNING

To avoid hazardous electrical shock, do not perform electrical tests when there are signs of shipping damage to any portion of the outer enclosure (covers and panels).

Inspect the shipping container for damage. If the shipping container or cushioning material is damaged, it should be kept until the contents of the shipment have been checked for completeness and the instrument has been checked mechanically and electrically. The procedures for checking electrical performance are given in Section IV, Performance Tests. If the contents are incomplete, if there is a mechanical defect, or if the instrument does not pass the performance tests, notify the nearest Hewlett-Packard office. If the shipping container is damaged or the cushioning material shows signs of stress, notify the carrier and the Hewlett-Packard office. Keep the shipping material for the carrier's inspection.

2-3. PREPARATION FOR USE

2-4. Power Requirements

WARNING

To avoid the possibility of hazardous electrical shock, do not operate this instrument at line voltages greater than 126.5 Vac with line frequencies greater than 66 Hz. Leakage currents at these settings may exceed 3.5 mA.

Signal Generators require a power source of 115 (90 to 126) Vac or 230 (198 to 252) Vac, 48 to 66 Hz, single phase. Signal Generators with Option 003

have the additional capability of operating with line frequencies of 48 to 440 Hz. However, operation at line frequencies >66 Hz is limited to a nominal line voltage of 100 or 120 Vac. The power consumption of both versions is <200 VA.

WARNINGS

This is a Safety Class I product (i.e., provided with a protective earth terminal). An uninterruptible safety earth ground must be provided from the Mains power source to the product input wiring terminals, power cord, or supplied power cord set. Whenever it is likely that the protection has been impaired, the instrument must be made inoperative and secured against any unintended operation.

If the instrument is to be energized via an external autotransformer (for voltage reduction), make sure the common terminal is connected to neutral (that is, the grounded side of the mains supply).

2-5. Line Voltage and Fuse Selection



CAUTION

Before plugging this instrument into the Mains (line) voltage, be sure that the correct operating voltage and fuse have been selected.

A rear-panel line-power module permits operation from 90 to 126 Vac sources or from 198 to 252 Vac sources. The number visible in the window on the module indicates the nominal line voltage (100, 120, 220 or 240 Vac) to which the instrument must be connected. Verify that the line voltage selection card and the fuse are matched to the power source to be used. Refer to Figure 2-1, Line Voltage and Fuse Selection. Table 2-1 lists the ratings and HP part numbers for the replaceable fuses.

WARNING

For protection against fire hazards, the line fuse should be a 250V normal-blow fuse with the correct current rating.

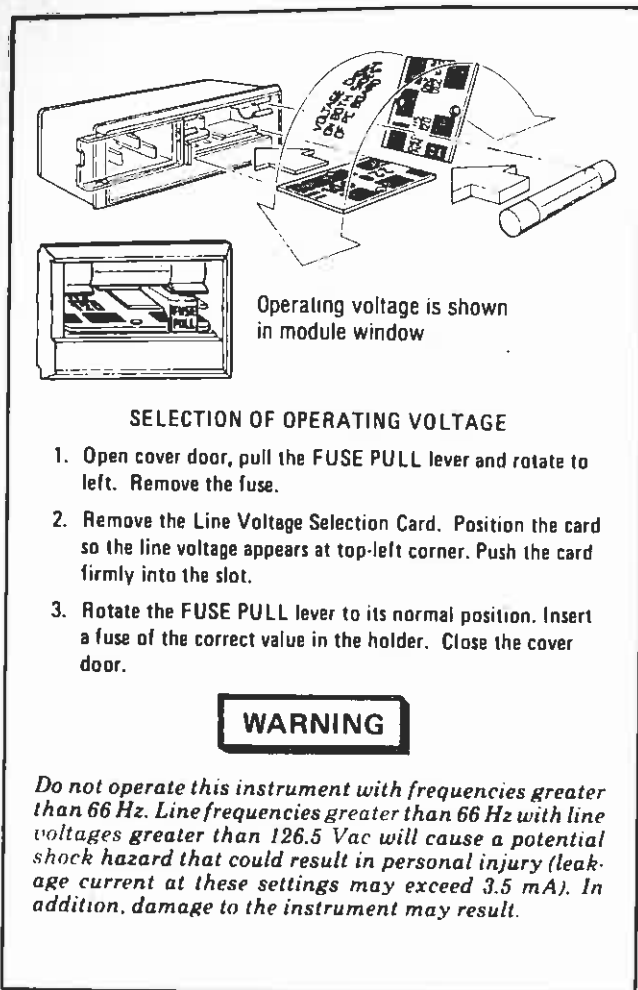

Figure 2-1. Line Voltage and Fuse Selection

Table 2-1. Fuse Ratings and Part Numbers

Line Voltage	Rating	Part Number
100/120V	3A, 250V	2110-0003
220/240V	1.5A, 250V	2110-0043

2-6. Power Cable

WARNING

Before connecting this instrument, the protective earth terminal of the instrument must be connected to the protective conductor of the (Mains) power cord. The Mains plug shall be inserted only in a socket outlet provided with a protective earth contact. The protective action must not be negated by the use of an

extension cord (power cable) without a protective conductor (grounding). Grounding one conductor of a two conductor outlet is not sufficient protection.

This instrument is equipped with a three-wire power cable. When connected to an appropriate ac power receptacle, this cable grounds the instrument cabinet. The type of power cable plug shipped with each instrument is determined by the country of destination. Refer to Figure 2-2 for the part numbers of the power cables and plugs available.

2-7. Mating Connectors

Coaxial Connectors. The front-panel RF OUTPUT connector and the rear-panel AUXILIARY OUTPUT connectors require 50-ohm Type N male mating connectors. All other input and output signal connectors require 50-ohm BNC male mating connectors. Both types must be compatible with the specifications of US MIL-C-39012.

2-8. Operating Environment

The operating environment should be within the following limitations:

- Temperature 0 to +55°C
- Humidity <95% relative
- Altitude <4570 metres (15 000 feet)

2-9. Bench Operation

The instrument cabinet has plastic feet and fold-away tilt stands for convenience in bench operation. The plastic feet are designed to ensure proper stacking with other instruments in similar housings, and the tilt stands raise the front of the Signal Generator for easier viewing of the front panel.

2-10. Rack Mounting

WARNING

The Signal Generator weighs 16.0 kg (35 lbs); therefore, care must be exercised when lifting to avoid personal injury. Use equipment slides when rack mounting.

Rack mounting information is provided with the rack mounting kits. If a kit was not ordered as an option with the Signal Generator, it may be purchased through the nearest Hewlett-Packard office. Refer to Mechanical Options in Section I for the part number.

 <p>220/240V OPERATION</p> <p>PLUG*: SEV 1011.1959-24507 TYPE 12 CABLE*: HP 8120-2104</p>	 <p>220/240V OPERATION</p> <p>PLUG*: NZSS 198/AS C112 CABLE*: HP 8120-1369</p>	 <p>100/120V OPERATION</p> <p>PLUG*: NEMA 5-15P CABLE*: 8120-1378</p>	 <p>220/240V OPERATION</p> <p>PLUG*: NEMA 6-15P CABLE*: HP 8120-0698</p>
 <p>220/240V OPERATION</p> <p>PLUG*: CEE7-VII CABLE*: HP 8120-1689</p>	 <p>220/240V OPERATION</p> <p>PLUG*: CEE22-V1 CABLE*: HP 8120-1860</p>	 <p>220/240V OPERATION</p> <p>PLUG*: BS 1363A CABLE: HP 8120-1351</p>	
<p>*The number shown for the plug is the industry identifier for the plug only. The number shown for the cable is an HP part number for a complete cable including the plug.</p>			

Figure 2-2. Power Cable and Plug Part Numbers

2-11. STORAGE AND SHIPMENT

2-12. Environment

The instrument should be stored in a clean, dry environment. The following environmental limitations apply to both storage and shipment.

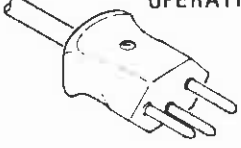
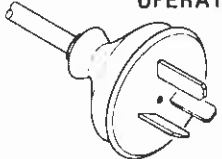
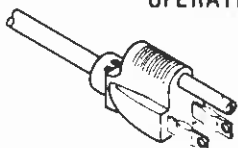
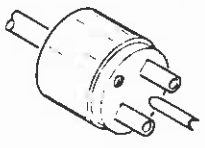
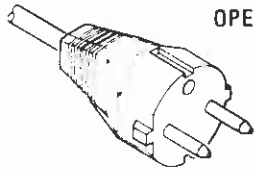
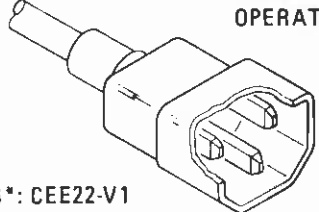
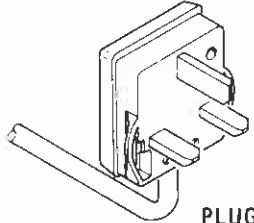
- Temperature -62°C to +85°C
- Humidity <95% Relative
- Altitude <15 300 metres (50 000 feet)

2-13. Packaging

Original Packaging. Containers and material identical to those used in factory packaging are available through Hewlett-Packard offices. If the instrument is being returned to Hewlett-Packard for servicing, please complete one of the blue repair tags located at the end of this manual and attach it to the instrument. Be sure to include the type of service required, return address, model number, and full serial number. Mark the container FRAGILE to assure careful handling. In any correspondence concerning a Hewlett-Packard instrument, refer to the instrument by model number and include the full serial number.

Other Packaging. The following general instructions should be followed for repackaging with commercially available packaging materials.

- a. Complete one of the blue service tags located at the end of this manual and attach it to the instrument. Be sure to indicate the type of service required, return address, model number, and full serial number. Then wrap the instrument in heavy paper or plastic.
- b. Use a strong shipping container. A double-wall carton made of 2.4 MPa (350 psi) test material is adequate.
- c. Use enough shock absorbing material (75 to 100 mm or 3 to 4 inch layer) around bottom, top, and all sides to provide a firm cushion and to prevent movement within the container.
- d. Seal the shipping container securely.
- e. Mark the shipping container FRAGILE to assure careful handling.

SECTION III OPERATION

3-1. INTRODUCTION

This section provides operating instructions for the Hewlett-Packard 8684B Signal Generator. It summarizes the major operating characteristics, describes controls and indicators, and provides operator's checks and an abbreviated performance test. It also explains how to set the output frequency, output level, modulation type, and modulation level. The function of each input and output connector is described in detail.

3-2. Operating Characteristics

Table 3-1 briefly summarizes the major operating characteristics of the Signal Generator. This table is not intended to be an in-depth listing of all characteristics. For more detailed information, refer to Table 1-1, Specifications, and Table 1-2, Supplemental Characteristics. Figure 3-1 provides a simplified description of the front-panel features, and Figure 3-2 provides a more detailed description of the display and control features. Figure 3-3 describes the rear-panel features.

Table 3-1. Operating Characteristics

<p>FREQUENCY Range: 5.4 GHz to 12.5 GHz Display Resolution: ≤ 5 MHz Calibration Accuracy: ≤ 9 GHz $\pm 1.25\%$ > 9 GHz $\pm 0.75\%$</p> <p>AMPLITUDE Range: +10 dBm to -130 dBm Display Resolution: 0.1 dB Level Accuracy: ± 2.5 dB (from maximum power down to -110 dBm) ± 3.5 dB (From < -110 dBm down to -120 dBm) Level Flatness: ± 1.0 dB for power levels > -10 dBm</p> <p>MODULATION AM Depth: 0 to 70% at a 1 kHz rate Rates (3 dB bandwidth): dc to 10 kHz Indicated Accuracy: $\pm 5\%$ of full scale for depths up to 50% at a 1 kHz rate Internal AM: Fixed 1 kHz square wave</p>	<p>FM Peak Deviation: 5 MHz Indicated Accuracy: (10 MHz/V range) $\pm 10\%$ of full scale for deviations up to 5 MHz at a 100 kHz rate Internal FM: 1 kHz sawtooth with variable deviation</p> <p>Pulse Internal: Adjustable rates of 10 Hz to 1 MHz, widths of < 100 ns to 100 ms, and delays of < 50 ns to 100 ms</p> <p>External Pulse Input Requirements Rate: 0 to 1 MHz Width: > 100 ns Input Levels: On > 1.0V Off < 0.4V</p> <p>Combined Modulation AM, FM, and pulse modulation may be combined.</p>
--	--



FREQUENCY Display

The FREQUENCY display provides a 3½-digit indication of carrier frequency over the range of 5.4 GHz to 12.5 GHz with a resolution of ≤ 5 MHz.

MODULATION Display

The MODULATION display provides a 3-digit indication of AM depth or FM deviation. The AM indication may range from 0 to 99.9% with an accuracy of approximately $\pm 5\%$ of full scale, and the FM indication may range up to 9.99 MHz peak deviation with an accuracy of approximately 10% of full scale. LED annunciators in the % AM and MHz FM keys indicate whether AM or FM data is being displayed. A separate OVERMOD annunciator illuminates when AM exceeds 99.8%, when FM deviation exceeds approximately 6 MHz peak, or when any dc superimposed on the external FM signal results in positive or negative peak input voltage greater than 1.2V. When AM and FM are used at the same time, the MODULATION display will remain in the last mode selected by the % AM or MHz FM keys. If the type of modulation being displayed is turned off, the MODULATION display is automatically switched to the remaining mode. If both AM and FM are turned off, the MODULATION display is blanked.

LEVEL Display

The LEVEL display provides a 3½-digit indication of the microwave output amplitude over the range of +10 dBm to -130 dBm with a resolution of 0.1 dB. The level displayed may be in dBm or dB relative, and the mode is indicated by a LED annunciator in the dBm key or the dB REL key. Selection of one mode automatically cancels the other mode.

The CABLE OFFSET key is an alternate action switch that turns the cable loss correction factor on or off. When its LED annunciator is not illuminated, the LEVEL display shows the power level at the OUTPUT connector of the Signal Generator. When the cable offset is turned on (CABLE OFFSET annunciator lighted) the displayed level remains the same; however, the actual output power level is increased (up to the maximum available level) to compensate for cable losses in up to four and one-half metres (14.7 feet) of RG-214 cable. The microprocessor uses the setting of the rear-panel CABLE OFFSET control and the indicated output frequency to calculate the offset correction. When the CABLE OFFSET key is held down, the LEVEL display shows the setting of the rear-panel CABLE OFFSET control.

LINE Switch

The LINE switch applies primary power to the Signal Generator.



FREQUENCY Control

The FREQUENCY control provides continuous tuning over the range of 5.4 GHz to 12.5 GHz. When pushed in for the normal tuning mode, it requires approximately 20 turns to cover the entire tuning range. When pulled out for the fine-tuning mode, it requires approximately 200 turns to cover the entire range.

Figure 3-2. Display and Control Features (1 of 4)

PULSE Mode Controls



The pulse mode controls include the INT PULSE, EXT TRIG, and EXT PULSE keys. Each key has a LED annunciator that illuminates when that particular mode is in operation, and the three modes are mutually exclusive; selection of one mode automatically cancels any previously selected mode. Actuation of any pulse mode control key with a lighted annunciator turns off all pulse modulation. Pulse modulation cannot be used in conjunction with the 1 kHz internal square wave.

When the INT PULSE mode is selected, the pulses are generated and controlled by the internal pulse generator; the RATE, DELAY, and WIDTH controls establish the pulse characteristics, and the RATE, DELAY, and WIDTH annunciators are illuminated to indicate that these controls are in operation. The UNCAL annunciator will light if an improper combination of rate and delay or rate and width is selected.

When the EXT TRIG mode is selected, the internal rate generator is disabled and the pulse rate is determined by the external trigger. The DELAY and WIDTH controls will still be in operation and this will be indicated by their annunciators. The RATE annunciator will be off, and the INPUT annunciator will be on to indicate that an external signal is required. The UNCAL annunciator will light if the DELAY or WIDTH control settings are not compatible with the external trigger rate.

When the EXT PULSE mode is selected, the RATE, DELAY, and WIDTH controls are disabled and their annunciators will be off. The pulse rate and pulse width will be determined by the rate and width of the pulses applied to the INPUT connector. The INPUT annunciator will be on to indicate that an external pulse is required. The UNCAL indicator does not operate when in the EXT PULSE mode because the detection circuitry has no way of monitoring control settings on an external source.

Int 1 kHz Square Wave Control



Selection of the INT 1 kHz mode provides internally generated amplitude modulation in the form of a square wave with a 50% duty cycle and an on/off ratio of >80 dB. The 1 kHz internal square wave cannot be used in conjunction with any of the pulse modulation modes.

PULSE INPUT Connector



The PULSE INPUT connector is used in the EXT TRIG mode to connect an external trigger signal and in the EXT PULSE mode to connect an external modulating pulse to the Signal Generator. When either mode is selected, the adjoining LED annunciator lights to indicate that an external signal is required for pulse modulation. The input impedance is 50 ohms, and the maximum input level is $\pm 5V$ peak.

Figure 3-2. Display and Control Features (2 of 4)

SIMPLIFIED FRONT PANEL FEATURES

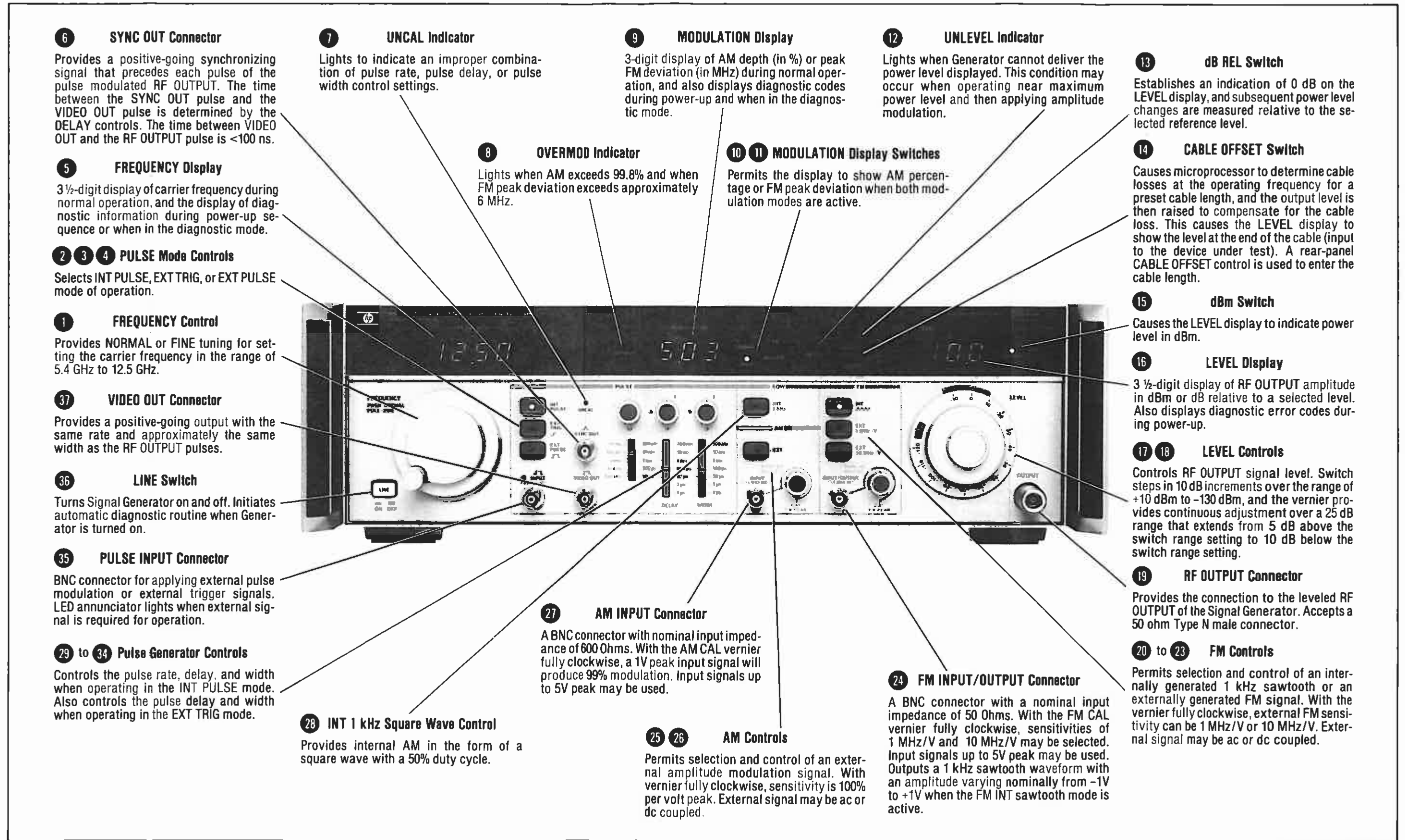

Figure 3-1. Simplified Front Panel Features

SYNC OUT Connector



The SYNC OUT connector provides a >1 volt peak positive synchronizing pulse (into 50 ohms). The DELAY controls determine the delay between the SYNC OUT pulse and the VIDEO OUT pulse. The SYNC OUT pulse is approximately 20 ns wide.

VIDEO OUT Connector



The VIDEO OUT connector provides a >3 volt peak positive pulsed signal (into 50 ohms). It has the same rate and approximately the same width as the RF OUTPUT pulse. The RF OUTPUT pulse occurs <100 ns after the VIDEO OUT pulse, and the pulse width compression (width of the VIDEO OUT pulse minus the width of the RF OUTPUT pulse) is <50 ns.

Pulse Generator Controls

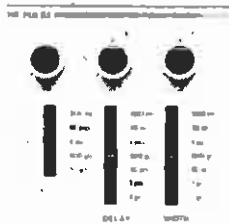

The pulse generator controls provide a range switch, a vernier control, and an annunciator associated with each of the three basic functions of rate control, delay control, and width control. The RATE switch permits selection of five ranges (10 Hz to 100 kHz in decade steps), and the vernier control provides continuous adjustment over a range that extends from one times the switch setting to ten times the switch setting. This provides an overall pulse rate range of 10 Hz to 1 MHz. The RATE annunciator is illuminated only when the INT PULSE mode is selected. In all other modes, the pulse rate is determined by external sources.

The DELAY switch permits selection of seven ranges (0.1 μ s to 100 ms in decade steps), and the vernier control provides continuous adjustment over a range that extends from one-tenth the value of the switch setting to the value of the switch setting. This provides an overall pulse delay range of <50 ns to 100 ms. The DELAY annunciator is illuminated when the INT PULSE or EXT TRIG mode is selected, and is off when the EXT PULSE mode is selected.

The WIDTH switch permits selection of seven ranges (0.1 μ s to 100 ms in decade steps), and the vernier control provides continuous adjustment over a range that extends from one-tenth the value of the switch setting to the value of the switch setting. This provides an overall pulse width range of <100 ns to 100 ms. The WIDTH annunciator is illuminated when the INT PULSE or EXT TRIG mode is selected, and is off when the EXT PULSE mode is selected.

Any one of the pulse modulation modes may be combined with frequency modulation and/or externally supplied amplitude modulation.

AM Controls



AM controls are provided for the selection and control of an external modulating signal. With the AM vernier control set fully clockwise, the AM sensitivity is nominally 100% per volt peak at the AM INPUT connector. The vernier permits reduction of the amplitude modulation down to <1%. The AM EXT annunciator will light when the external AM mode is selected. When the vernier control knob is pushed in, the external modulating signal is dc coupled; when the knob is pulled out, the signal is ac coupled. The input impedance is 600 ohms. Amplitude modulation may be combined with pulse modulation and/or frequency modulation.

Figure 3-2. Display and Control Features (3 of 4)

FM Controls

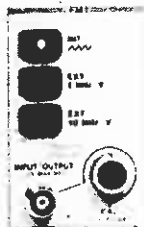

FM controls are provided for the selection of an internal 1 kHz sawtooth, and selection of external FM with a deviation sensitivity of 1 MHz/V or 10 MHz/V. An annunciator in each key lights to indicate which mode has been selected. Since the three modes are mutually exclusive, the selection of one mode will automatically cancel any previously selected mode. Actuation of an FM control key with a lighted annunciator will turn off all frequency modulation. When the vernier control knob is pushed in, the external modulation signal is dc coupled; when the knob is pulled out, the signal is ac coupled. The vernier permits deviation control from the maximum specified deviation down to less than 1 MHz. The input impedance is 50Ω. Frequency modulation may be combined with pulse modulation and/or amplitude modulation.

When operating in the FM INT sawtooth mode, the 1 kHz sawtooth that generates the frequency modulation is also available at the FM INPUT/OUTPUT connector. It has a rate of 1 kHz, and varies approximately from -1V to +1V. The FM vernier control has no effect on this signal. When using this sawtooth output, the external load impedance should be greater than 1 kΩ.

LEVEL Control



The RF output level of the Signal Generator is controlled by a step attenuator and a vernier control. The output level can be varied over the range of +10 dBm to -130 dBm with a resolution of 0.1 dB. The attenuator steps in increments of 10 dB while the vernier provides a 25 dB control range that extends from 5 dB above the selected range to 10 dB below the selected range. The gray area above the LEVEL switch indicates the vernier range available for any given switch setting.

UNLEVEL Indicator



The UNLEVEL indicator lights when the Signal Generator cannot deliver power equal to the level displayed. This condition may occur when operating near the maximum power level and then applying amplitude modulation or applying a cable offset correction.

OUTPUT Connector



The front-panel RF OUTPUT connector is the primary microwave output connector, and it provides some degree of reverse power protection (refer to Table 1-2, Supplemental Characteristics). The RF OUTPUT connector accepts 50Ω Type N male connectors.

Figure 3-2. Display and Control Features (4 of 4)

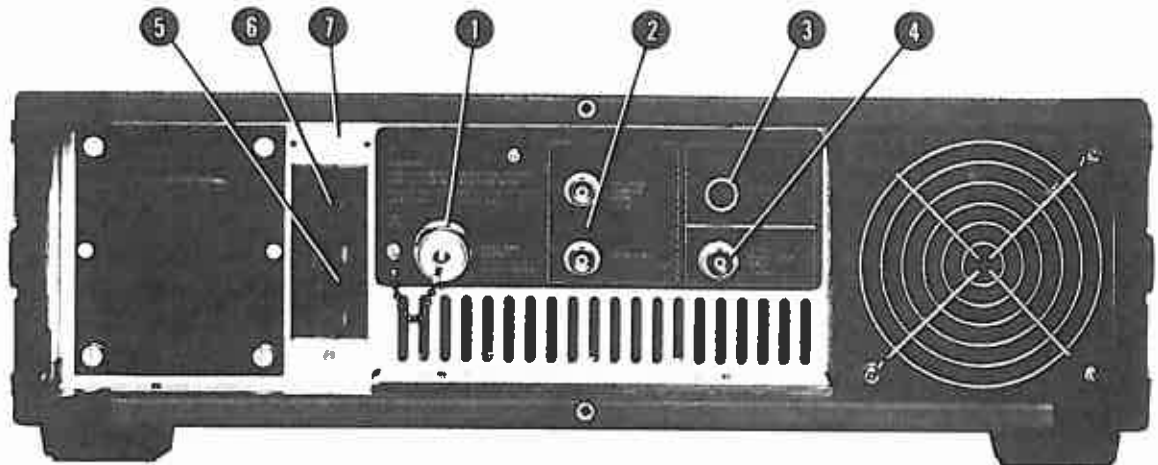

1 AUXILIARY OUTPUT Connector

The AUXILIARY OUTPUT connector provides an unlevelled sample of the oscillator output signal that is typically >-15 dBm into 50 Ohms. This sample is derived from the oscillator output prior to the amplitude modulation and pulse modulation circuits, so AM and pulse modulation are not available in the signal. It will contain any FM component in the oscillator output. The rear-panel AUXILIARY OUTPUT connector accepts a male Type N connector. The protective cap must be installed when the AUXILIARY OUTPUT is not in use; without the cap, RF leakage might produce erroneous results when testing at low signal levels.

CAUTION

Never apply reverse power to the AUXILIARY OUTPUT connector. There is no reverse power protection at this point, and reverse power may destroy the microwave amplifier and the oscillator.

2 OUTPUT TO RECORDER Connectors

The recorder outputs include the RELATIVE VERNIER LEVEL output and the FREQUENCY output. The RELATIVE VERNIER LEVEL output provides an analog signal of 0V to 10V scaled at 2.5 dB/V to represent the 0 dB to 25 dB attenuation range of the front-panel LEVEL vernier control. The FREQUENCY output provides an analog signal of 0V to 10V that represents the specified frequency range.

The loads connected to the recorder outputs should have an impedance greater than 1 M Ω .

3 CABLE OFFSET Control

The CABLE OFFSET control provides a cable loss correction for up to 4.5 metres (14.7 feet) of RG-214

coaxial cable. When the CABLE OFFSET mode is selected by the front-panel control, the microprocessor applies a correction to the leveled output power and the display shows the power level at the end of the cable (input to device under test). The correction factor is based upon the predicted cable losses at the selected output frequency.

4 PHASE LOCK INPUT Connector

The PHASE LOCK INPUT connector provides a control feature that may basically be considered an inverted FM control input. It has a sensitivity of -5 MHz/V, and the input level should not exceed ± 2 volts. When phase locking the Signal Generator output to an external signal, there are two input bandwidths available. Selecting either external FM mode provides a wide input bandwidth. Turning off all FM provides a narrow input bandwidth.



5 Fuse

3A, 250V, Normal-Blow for 100/120V ac operation, or 1.5A, 250V Normal-Blow for 220/240V operation. Ordering information is presented in Section II Installation.

6 Line Power Module

Permits operation from 100, 120, 220, or 240 Vac. The number visible in the window indicates the nominal line voltage to which the instrument must be connected (see Figure 2-1). The center conductor is the safety earth ground.

7 Serial Number Plate

The first four digits and a letter constitute the prefix which defines the instrument configuration. The last five digits form a sequential suffix that is unique for each instrument. The plate also identifies any options supplied with the instrument.

Figure 3-3. Rear Panel Features

3-3. OPERATOR'S CHECKS

1. Press LINE switch and verify that FREQUENCY, MODULATION, and LEVEL displays are filled with minus signs, go blank, and then are filled with eights. Refer to Table 3-2 if any error codes appear on the displays.

2. Rotate FREQUENCY control and verify that the FREQUENCY display responds to the changes in frequency.

3. Rotate the LEVEL step switch through steps and verify that the LEVEL display moves in 10 dB steps.

4. Rotate the LEVEL vernier and verify that the LEVEL display responds to the changes.

5. Press FM INT  key and verify that its annunciator lights, the MODULATION display lights, and the MHz FM annunciator lights.

6. Rotate the FM vernier and verify that the MODULATION display responds to the changes in FM deviation. Rotate the FM vernier to the full clockwise position and verify that the OVERMOD annunciator lights.

7. Press AM EXT key and verify that its annunciator lights and that the MODULATION display changes from MHz FM to % AM.

8. Press AM EXT key and verify that its annunciator goes off.

Table 3-2. Power-up Error Codes

Frequency Display	Modulation Display Test Numbers	Test	Power-up Error Code Numbers
5.25V	00	+5 Volt Power Supply	E50
6.20V	01	+6.2 Volt ALC Reference	E54
6.50V	02	+6.5 Volt microcircuit power supply	E55
15.00V	03	+15 Volt power supply	E51
-15.00V	04	-15 Volt power supply	E52
-30.00V	05	-30 Volt power supply	E53
-30.00 to 11.00V	06	Oscillator Power Supply-High Band	E57
-30.00 to 11.00V	07	Oscillator Power Supply-Low Band	E56
0.00V	10	Detector Differential on A6	E59
0.00V	11	Detector Amplifier on A6	E58
-9.00 to -0.5V	12	PIN Modulator Voltage A5TP4	E61
-0.1 to 5.00V	13	Multiplying DAC, ALC A7U5 Pin 8	E60
5.12V	16	#1 Freq. potentiometer, lower 1/3	E62
5.12V	17	#2 Freq. potentiometer, middle 1/3	E63
5.12V	18	#3 Freq. potentiometer, upper 1/3	E64
1. --	36	1. "--" means DAC is ok on bits 3—11 bits 0—2 not checked.	E10
2. e#		2. e# means this DAC bit is in error. If this error code is displayed all other error codes may be inaccurate.	
----	----	ROM checksum error	E01—E04
----	----	Front Panel checks	E05—E08
Table No.	----	Software can't find this software table	E09

OPERATOR'S CHECKS (cont'd)

9. Press FM INT  key and verify that its annunciator goes off.
 10. Press INT PULSE key; verify that its annunciator lights and that the MODULATION display is blanked.
 11. Verify that the RATE, DELAY, and WIDTH annunciators are lighted.
 12. Press INT PULSE key; verify that its annunciator goes off, and that the RATE, DELAY, and WIDTH annunciators go off.
 13. Press dB REL key; verify that its annunciator is lighted and that the LEVEL display shows 0.0.
 14. Press dBm key; verify that its annunciator is lighted and that the dB REL key annunciator goes off.
 15. Press and hold the CABLE OFFSET key; verify that its annunciator lights and that the LEVEL display shows a number in the range of 0.0 to 4.5 (this number is determined by the setting of the rear-panel CABLE OFFSET control).
 16. Release CABLE OFFSET key and verify that the LEVEL display returns to the settings established by the LEVEL switch and LEVEL vernier.
4. Tune Generator to 12.500 GHz and verify that the counter indicates between 12.375 GHz and 12.625 GHz.
 5. Disconnect frequency counter and connect power sensor of the power meter to the OUTPUT connector of the Generator.
 6. On the power meter, set the CAL FACTOR % control to the percentage indicated by the calibration chart on the power sensor. Then verify that the level indicated by the power meter is within ± 2.5 dB of that indicated by the LEVEL display on the Generator. If the measurement is out of tolerance, check CAL ADJ setting of the power meter and repeat measurement.
 7. Set Signal Generator LEVEL to -5.0 dBm and verify that the power meter indicates within ± 2.5 dB of that level.
 8. Momentarily press the dB (REF) switch on the power meter, and verify that the power meter indication goes to zero. Then tune the Generator from 12.500 GHz down to 5.400 GHz while observing output level flatness on the power meter. The total variation (highest to lowest power level) should be less than 2 dB. Be sure to change the CAL FACTOR % control on the power meter when necessary.
 9. Disconnect power sensor and connect the spectrum analyzer to the OUTPUT connector of the Generator. Tune both the Generator and the analyzer to approximately 9.0 GHz. The exact frequency is not important.

3-4. ABBREVIATED PERFORMANCE TEST

The following abbreviated performance test procedure requires a frequency counter, power meter, power sensor, spectrum analyzer, and a test oscillator. Refer to Table 1-3, Recommended Test Equipment, for the suggested model numbers.

1. Connect a frequency counter to the OUTPUT connector of the Signal Generator, and tune the Generator to 5.400 GHz.
2. Set Signal Generator LEVEL control for an output power level of approximately -15 dBm and adjust counter triggering level if necessary. The counter should indicate a frequency between between 5.346 GHz and 5.454 GHz.
3. Tune Generator to 9.000 GHz and verify that the counter indicates between 8.910 GHz and 9.090 GHz.
10. Adjust spectrum analyzer controls to place the peak of the signal at the top graticule line. Use a frequency span of 0.5 MHz/div., a bandwidth of 10 kHz, and a scan time of 20 ms/div.
11. On the Signal Generator, press the INT 1 kHz key and verify that its annunciator lights. Then verify that the spectrum analyzer shows a pulse spectrum with spectral components spaced 1 kHz apart.
12. Press the INT 1 kHz key again and verify that its annunciator goes off. Then press the FM INT  key and verify that its annunciator lights. The spectrum analyzer display should appear similar to the one shown in Figure 3-4.

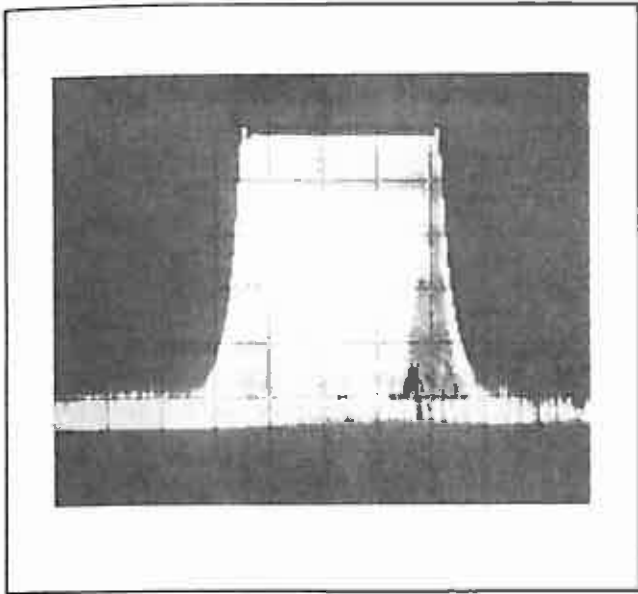



Figure 3-4. Sawtooth Spectrum

ABBREVIATED PERFORMANCE TEST (cont'd)

13. Press the FM INT  key again and verify that its annunciator goes off. Then step the LEVEL switch down in 10-dB increments to -120 dBm while watching the display on the spectrum analyzer. Verify that the steps are in fact 10 dB each. If the carrier signal cannot be seen all the way down to -120 dBm, then check the steps down to the lowest level that is visible.

14. Return the LEVEL switch to 0 dBm and verify that the peak of the carrier signal is on the top line of the spectrum analyzer graticule. Then tune the spectrum analyzer to approximately 18 GHz and check the level of the second harmonic. It must be at least 25 dB below the carrier level.

15. Return spectrum analyzer to 9.000 GHz. Press the Signal Generator's INT PULSE key, and verify that the key annunciator is lighted. Set Signal Generator PULSE controls for a 100 kHz pulse rate and a 2 μ s pulse width. The spectrum analyzer display should have a pulse spectrum with the lines spaced by 100 kHz and with minima every 500 kHz. Press INT PULSE key and verify that its annunciator is off.

16. Press AM EXT key and verify that its annunciator is lighted. Then connect the 600 Ω output of the test oscillator to the AM INPUT connector and turn the AM vernier fully clockwise. Set test oscillator output frequency to 10 kHz and output level to 0.354 Vrms. Verify that the MODULATION display on the Signal Generator shows about

50 \pm 5% AM. The 10 kHz sidebands on the spectrum analyzer must be 9 dB below the carrier. Press AM EXT key and verify that its annunciator is off.

3-5. OPERATING INSTRUCTIONS

Paragraphs 3-6 through 3-9 explain how to set the Signal Generator for the CW mode, AM mode, FM mode, and pulse mode. Two or three types of modulation may be combined when desired. The front panel controls used to set the various modes of operation are shown in Figure 3-1.

NOTE

The presence of a power-up error code when the instrument is turned on may not be significant. For instance, an error code indicating a faulty FM peak detector would not be significant if the Generator is to be used in the CW, AM, or pulse mode. In situations of this type, the maintenance activities required to restore the instrument can be handled on a routine basis when time permits.

3-6. CW MODE OPERATION

a. Press LINE switch (36) and verify that power-up diagnostics are completed without a significant error code display.

b. Using the FREQUENCY control (1), set desired frequency on the FREQUENCY display (5).

NOTE

If a higher frequency resolution is required, a frequency counter may be connected to the rear-panel AUXILIARY OUTPUT connector.

c. Using the LEVEL switch (17) and LEVEL vernier (18), set desired power level on the LEVEL display (16).

d. If the CABLE OFFSET feature is to be used, press and hold the CABLE OFFSET key (14) to display the CABLE OFFSET setting on the LEVEL display (16). If necessary, use rear-panel CABLE OFFSET control to establish correct setting.

3-7. AM MODE OPERATION

a. Press LINE switch (36) and verify that power-up diagnostics are completed without a significant error code display.

AM MODE OPERATION (cont'd)

b. Using the FREQUENCY control (1), set desired frequency in the FREQUENCY display (5).

NOTE

If a higher frequency resolution is required, a frequency counter may be connected to the rear-panel AUXILIARY OUTPUT connector.

c. Using the LEVEL switch (17) and LEVEL vernier (18), set desired power level in the LEVEL display (16).

d. If the CABLE OFFSET feature is to be used, press and hold the CABLE OFFSET key (14) to display the CABLE OFFSET setting on the LEVEL display (16). If necessary, use rear-panel CABLE OFFSET control to establish correct setting.

e. For internal AM operation, press SQW INT 1 kHz key (28) and verify that its annunciator lights. This will provide a 1 kHz square wave with a nominal 50% duty cycle.

CAUTION

In the next step, the maximum allowable input level is 5V peak.

f. For external AM operation, press AM EXT key (25) and verify that its annunciator lights. Then connect external modulation source to AM INPUT connector (27), and adjust external source level and/or AM vernier (26) to display desired modulation level (% AM) on the MODULATION display (9). The OVERMOD indicator (8) lights when an AM level above 99.8% is selected.

NOTES

At RF output levels near the maximum specified power, the application of high levels of amplitude modulation may cause the UNLEVEL indicator (12) to light. This occurs when the RF amplifier cannot deliver the power required for the indicated level of modulation. Lowering the RF output level or the modulation level will extinguish the UNLEVEL indicator.

External AM may be combined with FM and/or pulse modulation. The INT 1 kHz square wave may be combined with FM.

3-8. FM MODE OPERATION

a. Press LINE switch (36) and verify that power-up diagnostics are completed without a significant error code display.

b. Using the FREQUENCY control (1), set desired frequency on the FREQUENCY display (5).

NOTE

If a higher frequency resolution is required, a frequency counter may be connected to the rear-panel AUXILIARY OUTPUT connector.

c. Using the LEVEL switch (17) and LEVEL vernier (18), set desired power level on the LEVEL display (16).

d. If the CABLE OFFSET feature is to be used, press and hold the CABLE OFFSET key (14) to display the CABLE OFFSET setting on the LEVEL display (16). If necessary, use rear-panel CABLE OFFSET control to establish correct setting.

e. For internal FM operation, press FM INT  key (20) and verify that its annunciator lights. This will provide a 1 kHz sawtooth output.

f. Set FM deviation by using FM vernier (23) to obtain the desired modulation level (MHz FM) on the MODULATION display (9).

CAUTION

In the next step, the maximum allowable input level is 5V peak.

g. For external FM operation, press FM EXT 1 MHz/V key (21) or FM EXT 10 MHz/V key (22) and verify that its annunciator lights. Then connect external FM source to the FM INPUT/OUTPUT connector (24), and adjust external source level and/or FM vernier (23) to display the desired modulation level (MHz FM) on the MODULATION display (9). The OVERMOD indicator (8) lights when a peak deviation of 6.1 MHz or higher is selected.

NOTE

FM may be combined with AM and/or pulse modulation.

3-9. PULSE MODE OPERATION

a. Press LINE switch (36) and verify that power-up diagnostics are completed without a significant error code display.

b. Using the FREQUENCY control (1), set desired frequency on the FREQUENCY display (5).

NOTE

If a higher frequency resolution is required, a frequency counter may be connected to the rear-panel AUXILIARY OUTPUT connector.

c. Using the LEVEL switch (17) and LEVEL vernier (18), set desired power level on the LEVEL display (16).

d. If the CABLE OFFSET feature is to be used, press and hold the CABLE OFFSET key (14) to display the CABLE OFFSET setting on the LEVEL display (16). If necessary, use rear-panel CABLE OFFSET control to establish correct setting.

NOTE

After completing step d., skip to the internal pulse, external trigger, or external pulse mode as required.

Internal Pulse Mode Operation

e. Press INT PULSE key (2) and verify that its annunciator lights. The RATE, DELAY, and WIDTH annunciators will also light.

f. Set RATE switch (32) and RATE vernier (29) to the desired pulse rate.

g. Set DELAY switch (33) and DELAY vernier (30) to the desired pulse delay (time between SYNC OUT pulse and VIDEO OUT pulse).

h. Set WIDTH switch (34) and WIDTH vernier (31) to the desired pulse width.

NOTES

The UNCAL indicator (7) will light if an improper combination of RATE, DELAY, and WIDTH control settings is selected.

The internal pulse mode may be combined with AM and/or FM. It cannot be combined with the INT 1 kHz square wave.

External Trigger Mode Operation

i. Press EXT TRIG key (3) and verify that its annunciator lights. The DELAY and WIDTH annunciators will also light.

CAUTION

In the next step, the maximum allowable input level is 5V peak.

j. Set external trigger source for a compatible output (+5V peak) and connect it to the PULSE INPUT (35) connector.

k. Set pulse rate on the external trigger source.

l. Set DELAY switch (33) and DELAY vernier (30) to the desired pulse delay (time between SYNC OUT pulse and VIDEO OUT pulse).

m. Set WIDTH switch (34) and WIDTH vernier (31) to the desired pulse width.

NOTES

The UNCAL indicator (7) will light if the selected pulse delay or pulse width are not compatible with the externally generated pulse rate.

The external trigger mode may be combined with AM and/or FM. It cannot be combined with the INT 1 kHz square wave.

n. Press EXT PULSE key (4) and verify that its annunciator lights. The RATE, DELAY, and WIDTH annunciators will be off.

CAUTION

In the next step, the maximum allowable input level is 5V peak.

o. Set external pulse source for a compatible output level, and connect the source to the PULSE INPUT (35) connector.

p. Set pulse rate and pulse width as required on the external pulse source.

NOTE

The external pulse mode may be combined with AM and/or FM. It cannot be combined with the INT 1 kHz square wave.